



**User manual
Roof structure profile kit
Art. 173.295
UNIROOF 300/700**

**Leister Technologies AG
Galileo-Strasse 10
CH-6056 Kaegiswil/Switzerland
Tel. +41 41 662 74 74
Fax +41 41 662 74 16
www.leister.com
sales@leister.com**



We know how.

Easy welding of profiles

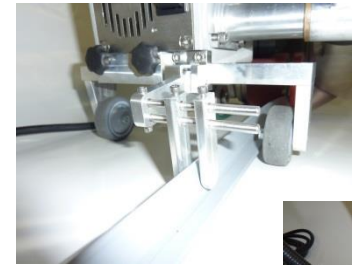

Welding with 30-40 mm
UNIROOF nozzle



Parts and tools for assembling



Step 1:

Assemble roller cover

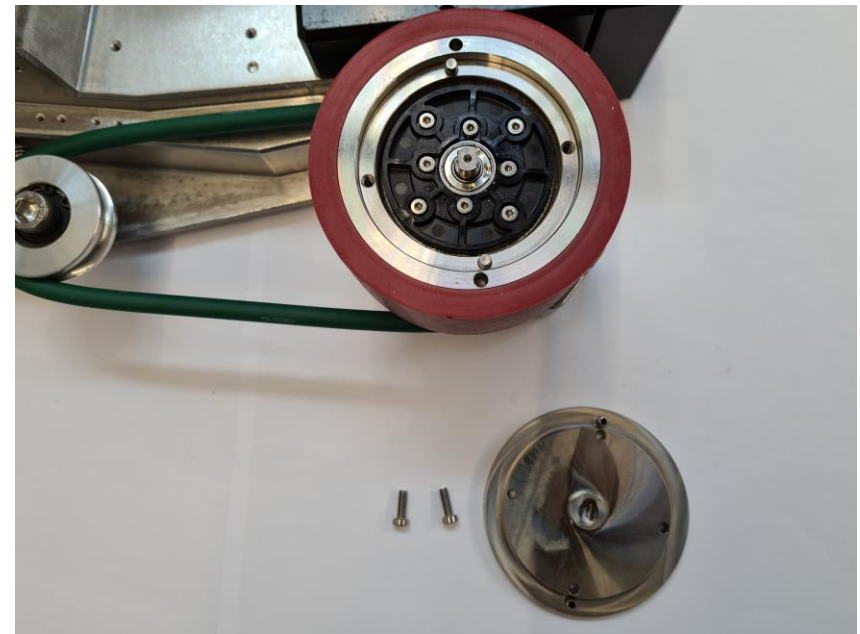
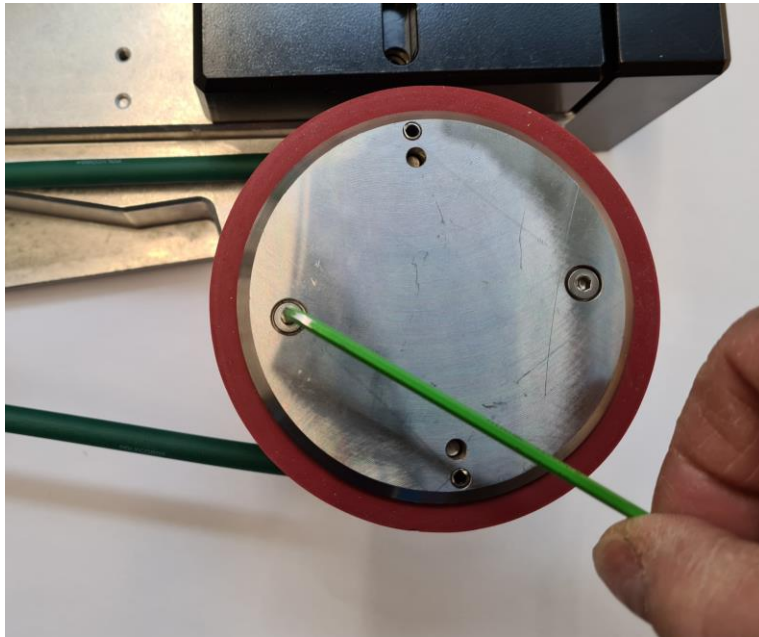

Step 2: Assemble guiding roller

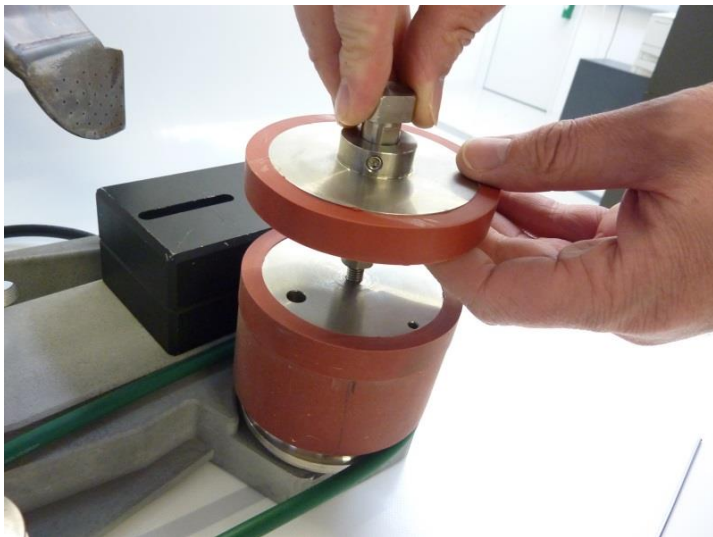
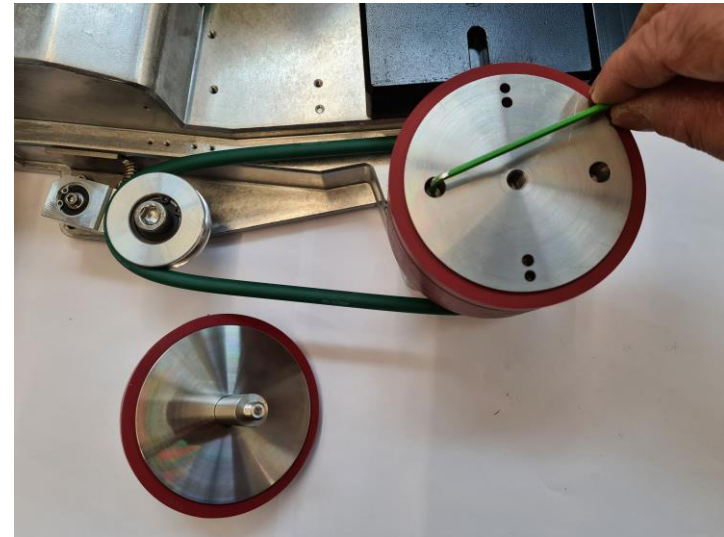
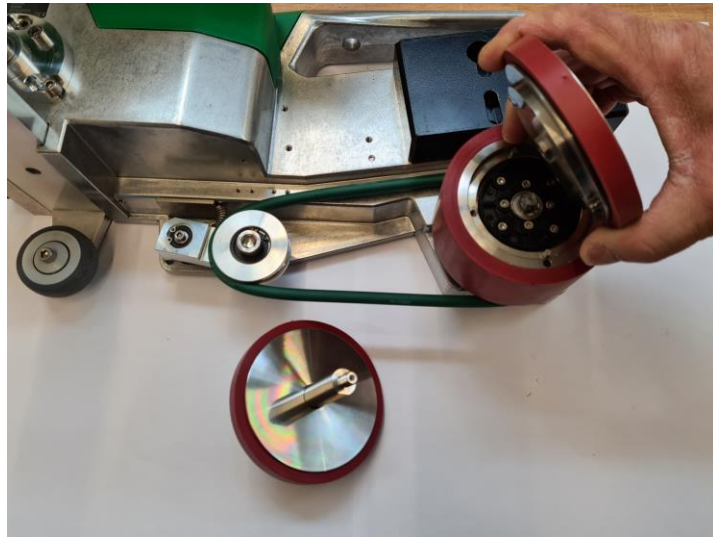

Step 3: Assemble flange for pivot axis

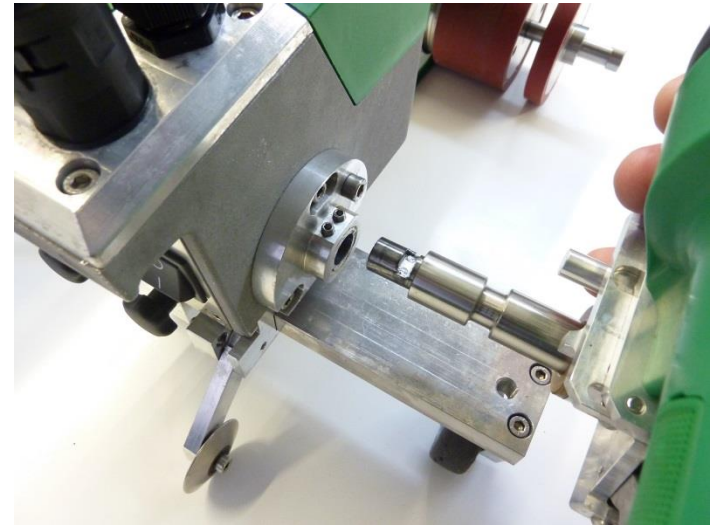

Step 4: Assemble flange for pivot axis

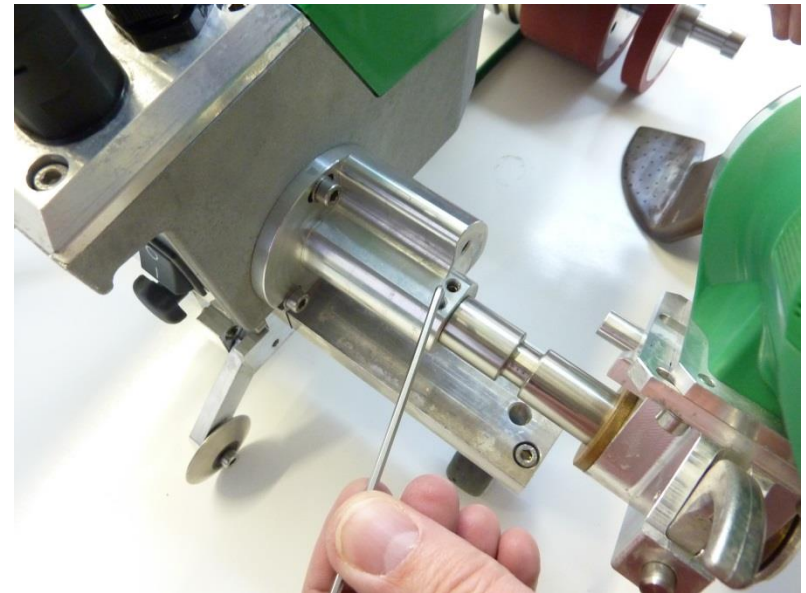
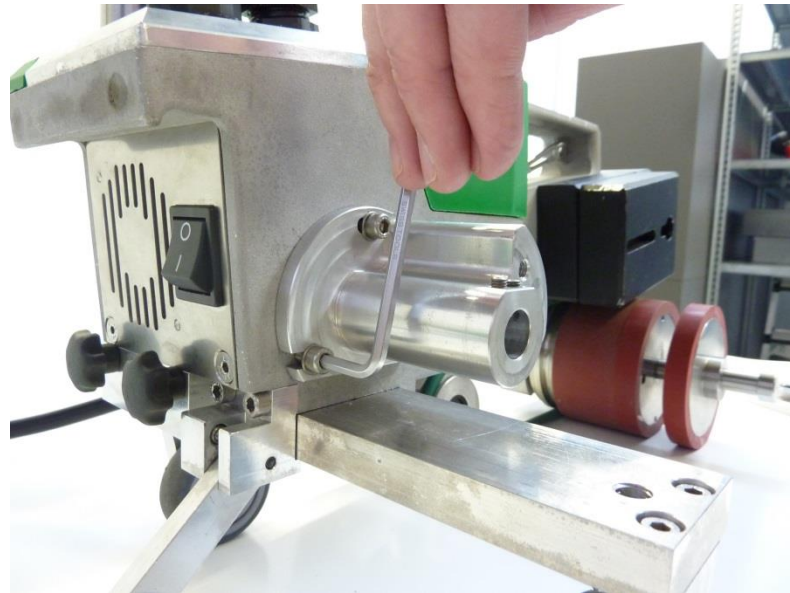

Step 5: Change guiding roller

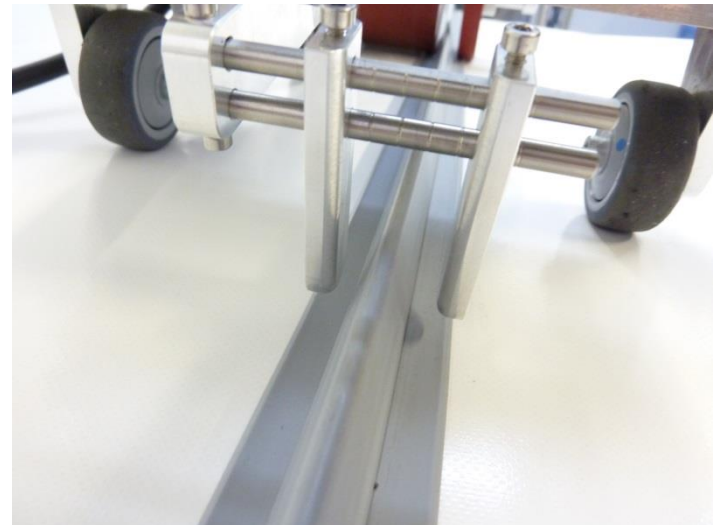
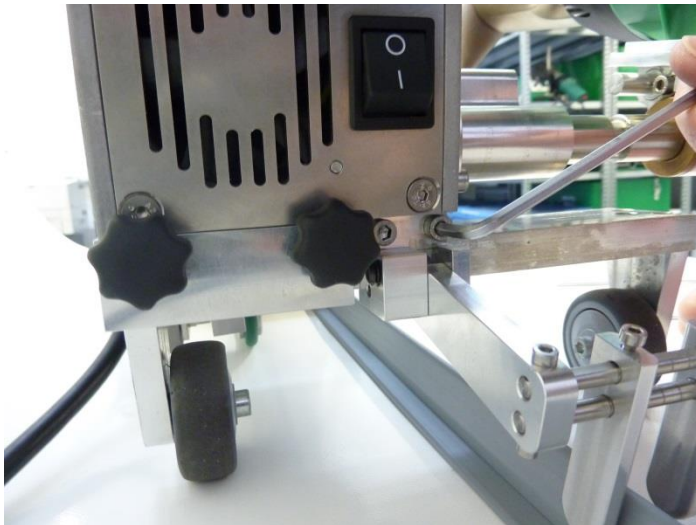
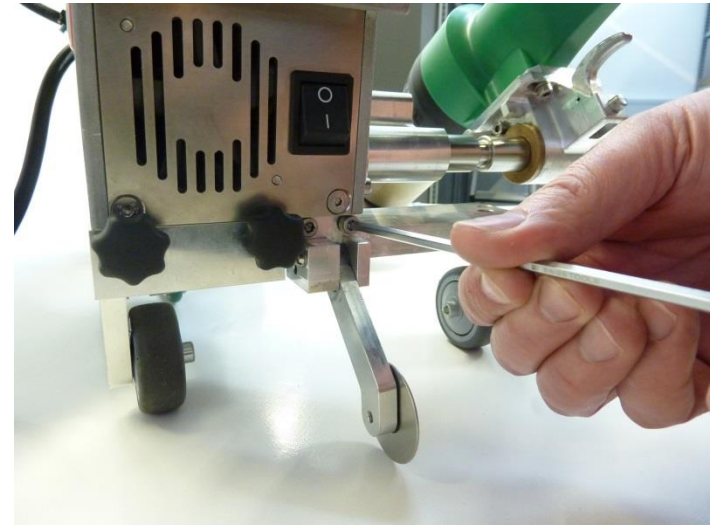
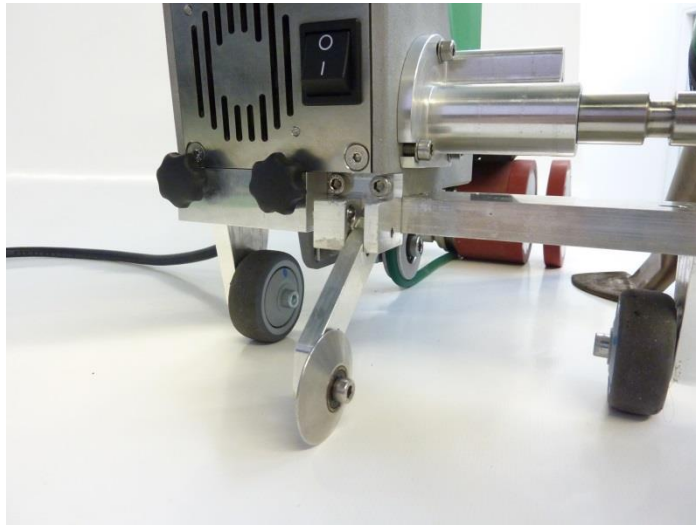
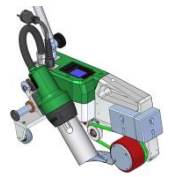

Step 6: Ajust pressure roller

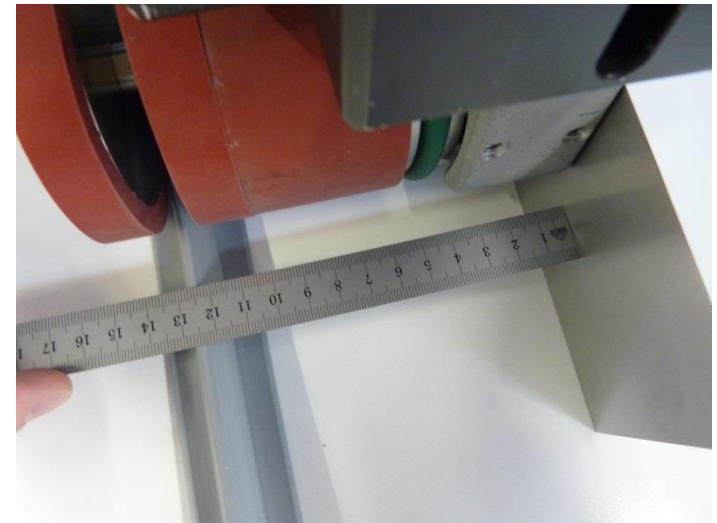
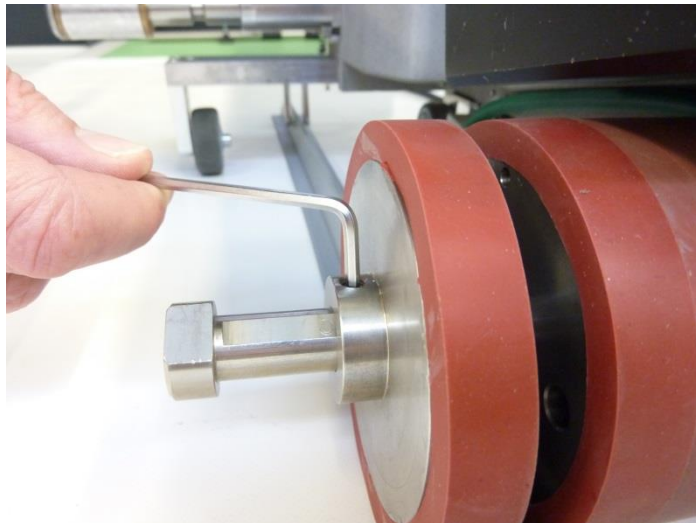
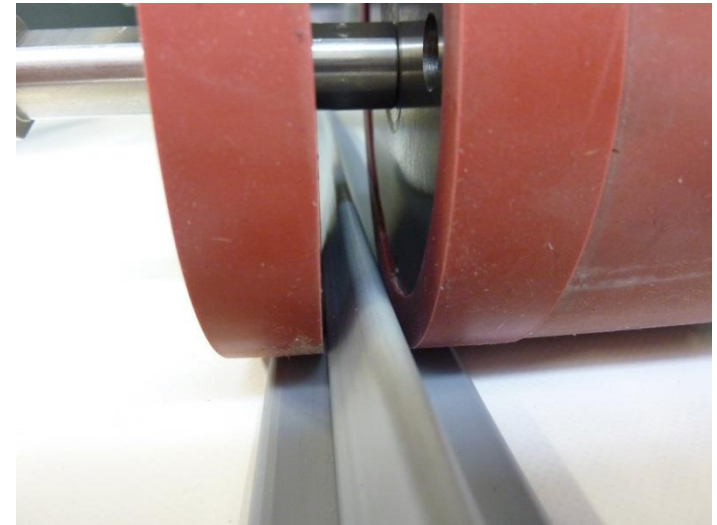
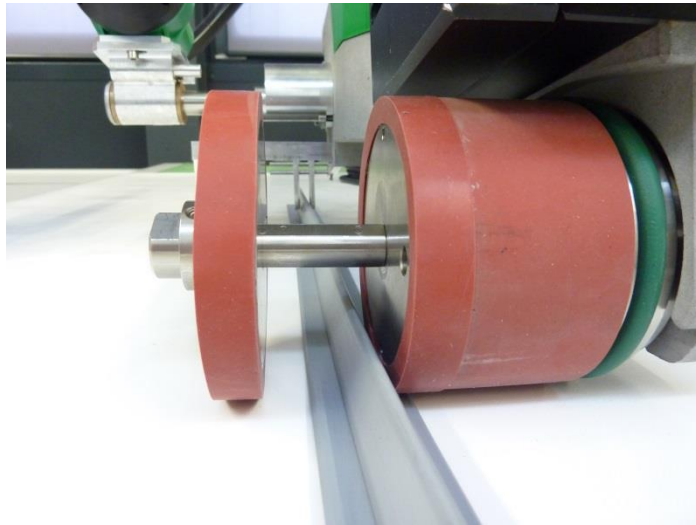

Step 7: Ajust guide

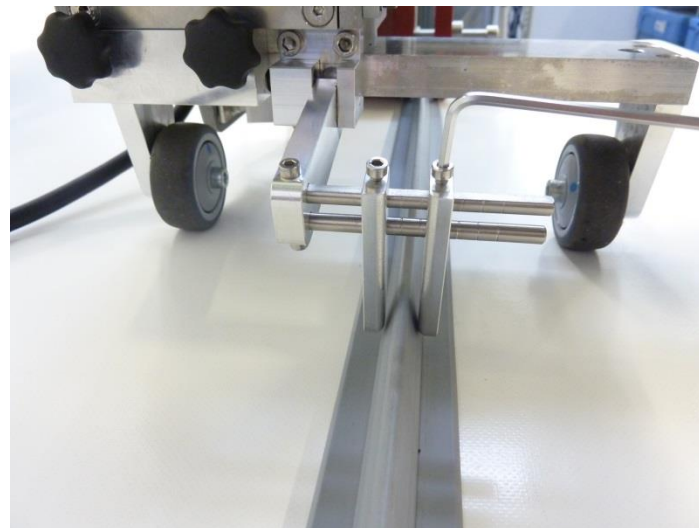
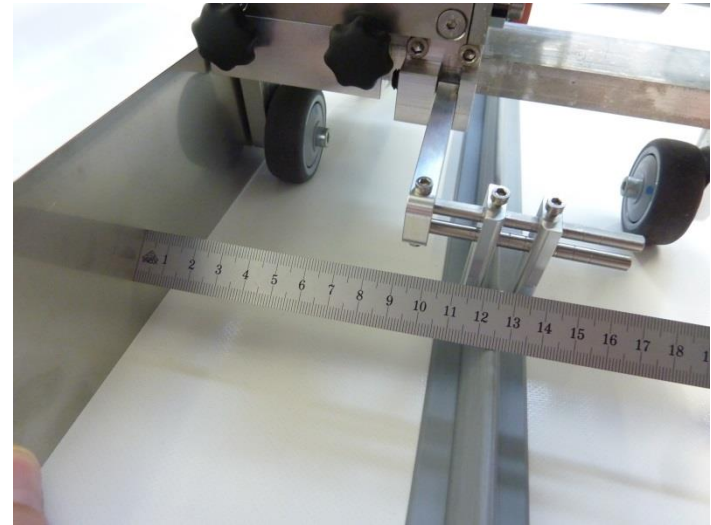
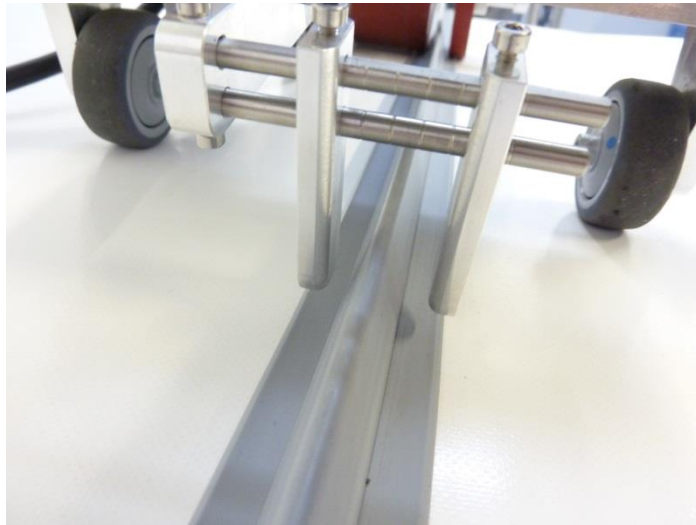

Step 8:

Change nozzle from 40mm to 30mm

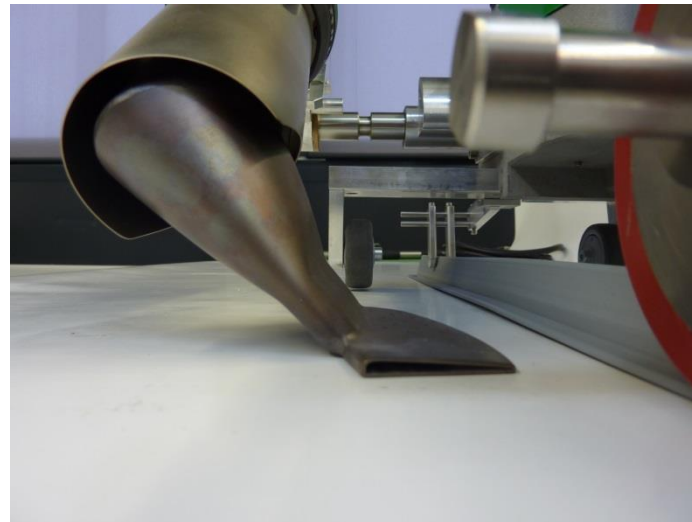
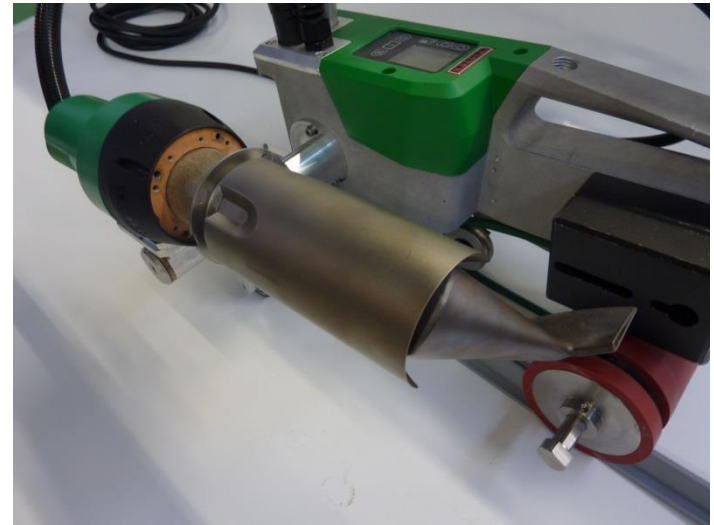
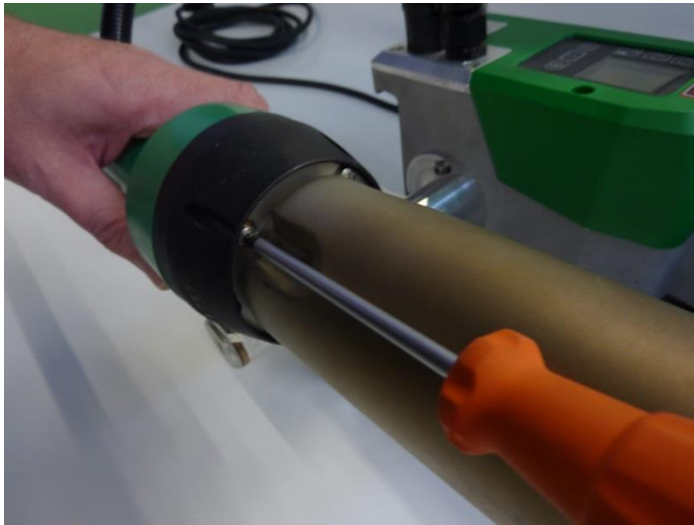
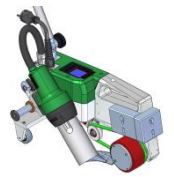

Step 9: Adjust nozzle

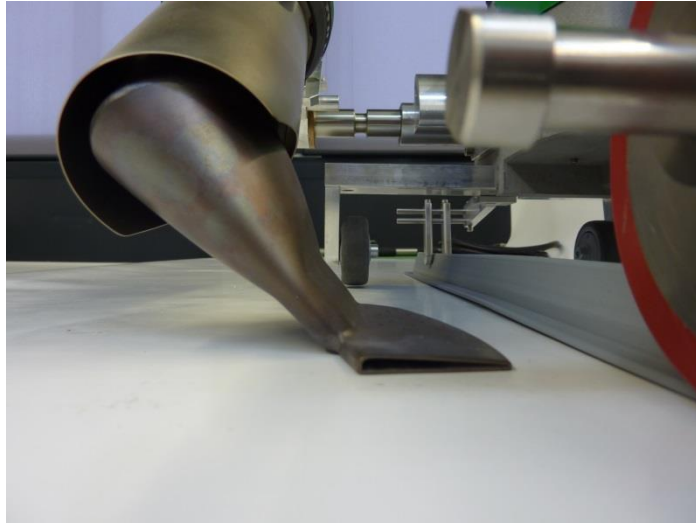
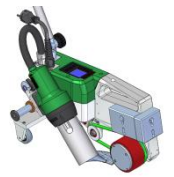

Adjust nozzle flat

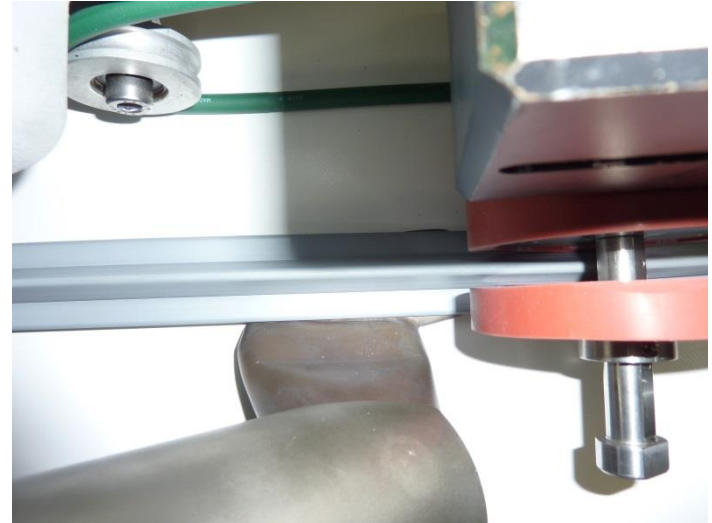

Adjust nozzle centered on
structural profile

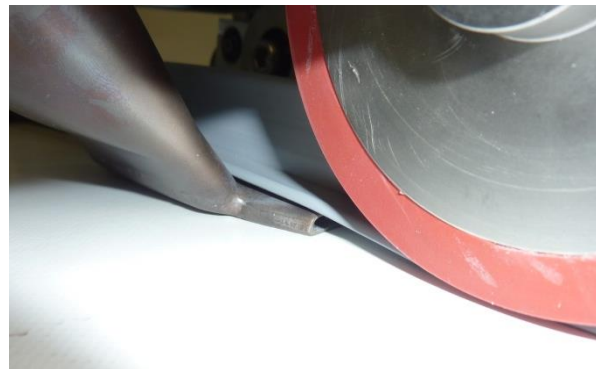

Step 10:

Setting the transport axis

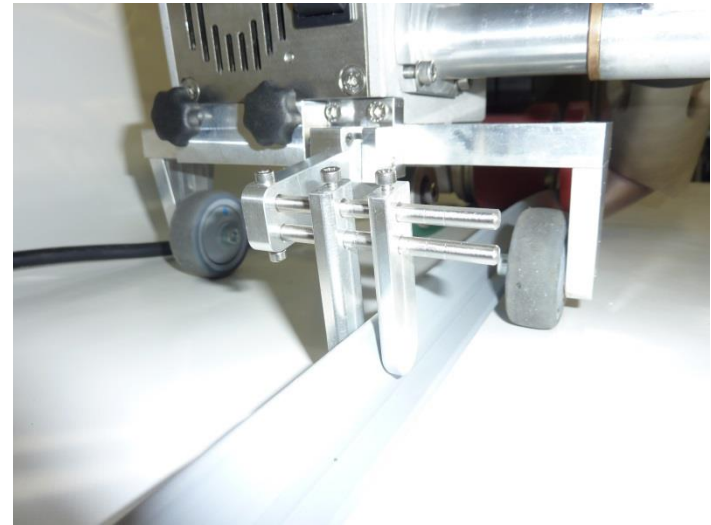
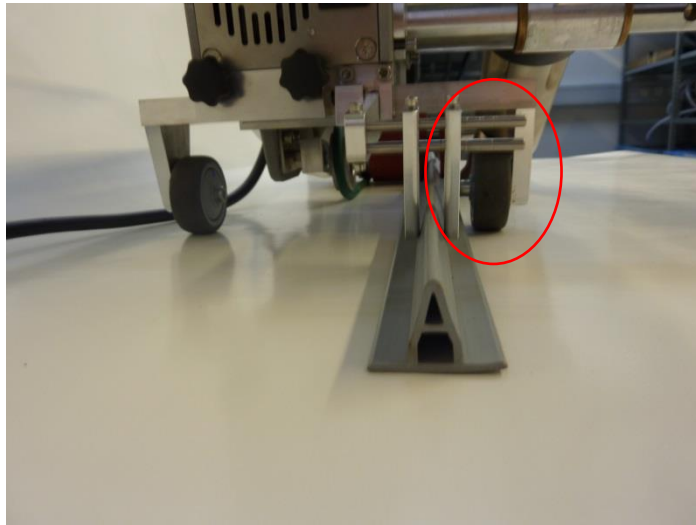

Setting the Right wheel as close to the structure profile.

The recommended transport axis is the **300mm** axis.

Assembly drawing

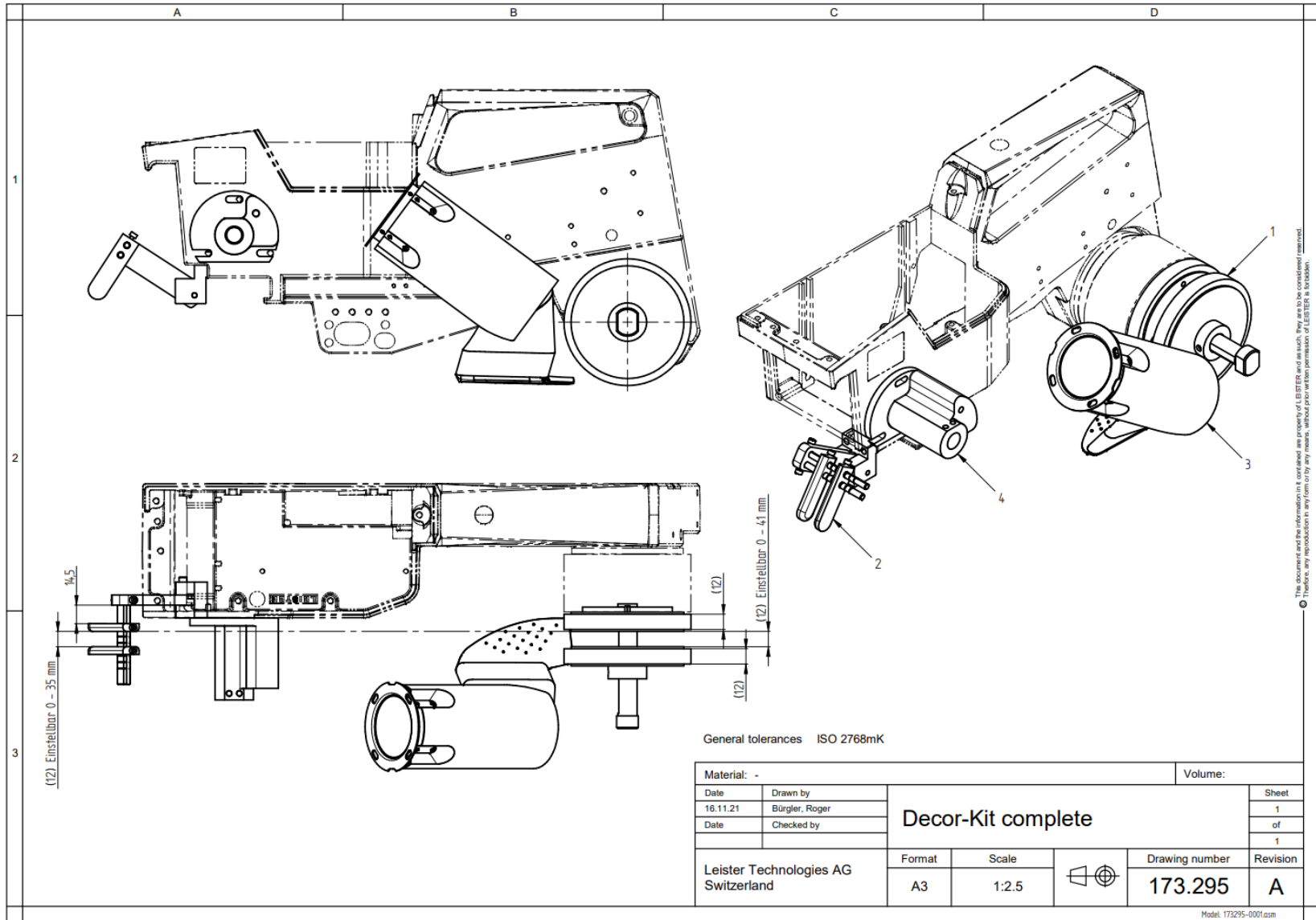

This document and its contents are the property of LEISTER and its subsidiaries. They shall be considered reserved.
 The use, the reproduction or any form of publication in any form is prohibited without the prior written permission of LEISTER Technology.



Part list



Pos.	Pcs	Number	Part
1	1	173.294	Pressure roller complete
2	1	153.262	Decor-Kit guiding
3	1	155.326	Overlap welding nozzle
4	1	153.015	Flange

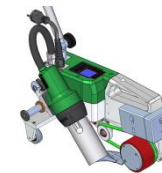

Your authorised Service Centre is:

Leister Technologies AG
Galileo-Strasse 10
CH-6056 Kaegiswil/Switzerland
Tel. +41 41 662 74 74
Fax +41 41 662 74 16
www.leister.com
sales@leister.com

BA Roof structure profile kit / 11.2021
Artikel Nr. 173.296